

Quick Reference

EKTALITE

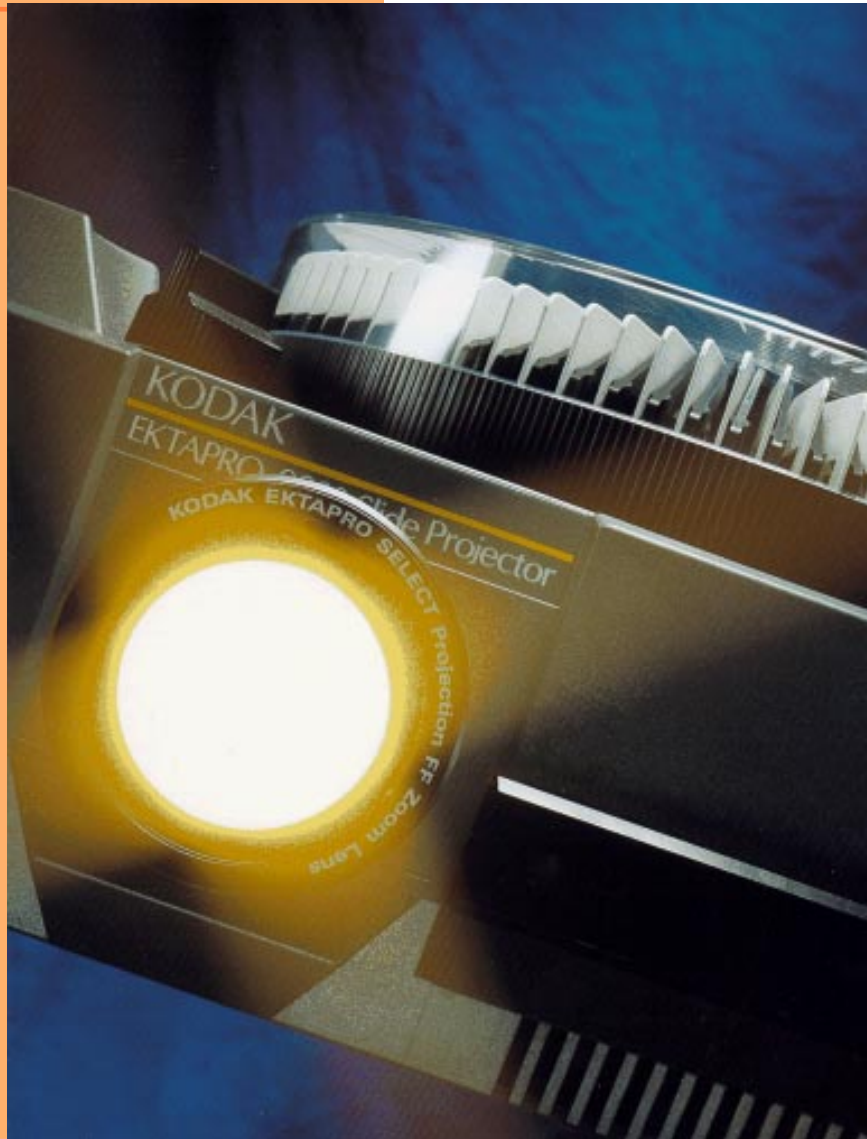

The Quick Reference - is designed to be your ultimate source to all applications, technical constellations, accessories etc. for **Kodak Ektalite Slide Projectors**

Content

Accessories	3
Remote Control	
Cable	4
Infrared.....	5
IR + Extension Cable.....	6
Parallel Projection	
IR and 2 Receivers.....	7
Cable Remote + Twin Socket.....	8
Endless Projection	
Timer.....	9
Autofocus	10
Slide Recording	11
Lenses	
General.....	12
Lamps	
General.....	13
Extra Bright Light Module	
General.....	14
Lumen Output / Compatibility.....	15
Safety Precautions.....	16
Carrying Case	17
Stackloader	18
External Control	19
Specification	
Dimensions.....	20
Connectors.....	21
Applications	
Control via MIDI.....	22
Addresses	23
Editorial	27

Accessories

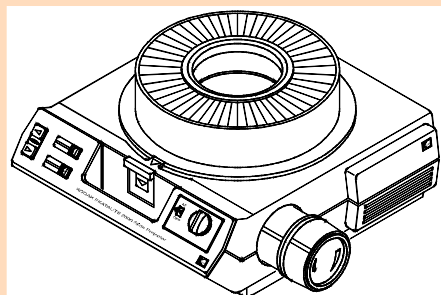

Product	CAT NO
EKTALITE IR Remote Control	873 5086
EKTALITE Cable Remote	861 8936
KODAK S-AV Extension Cable 4 m	701 5662
EKTALITE Extension Cable 16 m	866 0573
EKTALITE 12 Pin Adaptor	861 9629
EKTALITE Extra Bright Lamp Module	871 9767
EXR Projection Lamp - 35 h	145 2259
FHS Projection Lamp - 70 h	147 7678
EXY Projection Lamp - 200 h	145 2143
Lenses (see section "Lenses")	
EKTALITE Carrying (Soft) Case	162 5136
KODAK EC Stack Loader	151 4249
EKTAPRO 80 Slide Tray	712 8580
TRANSVUE 140 Slide Tray	184 0768



Remote Control Cable

■ General

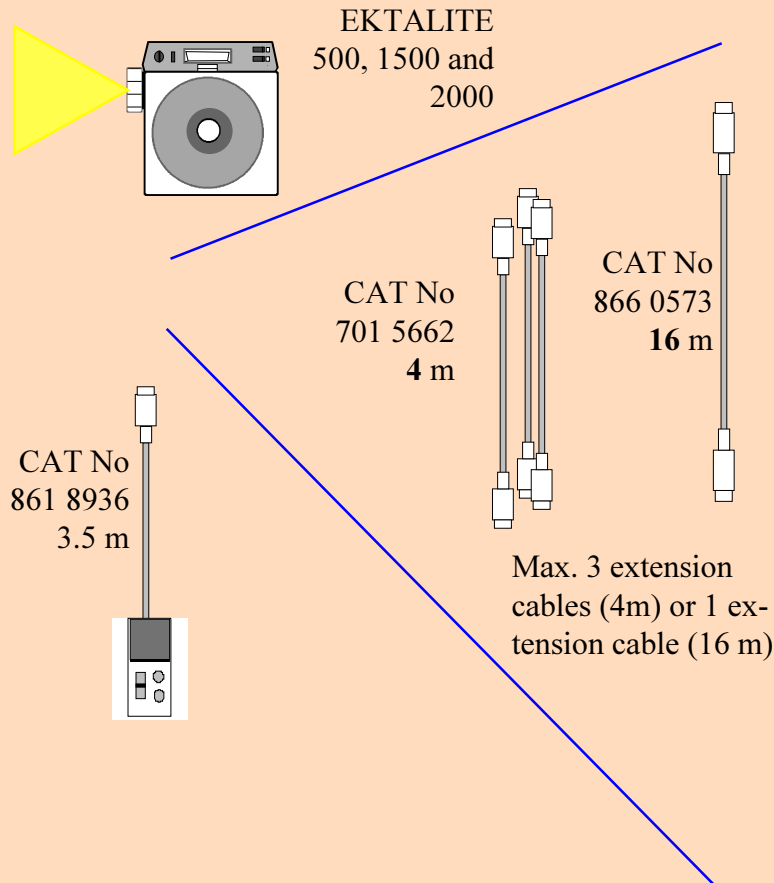

EKTALITE Cable Remote CAT No 861 3936	1	1	1	1	1
Extension Cable 4 m CAT No 701 5662		1	2	3	
Extension Cable 16 m CAT No 866 0573					1
Total Cable Length	3.5 m	7.5 m	11.5 m	15.5 m	19,5 m

Remote Control IR + Extension Cable

- 1 Ektalite Projector, IR Remote Control and 16 m Extension Cable for optimal placement of IR Receiver

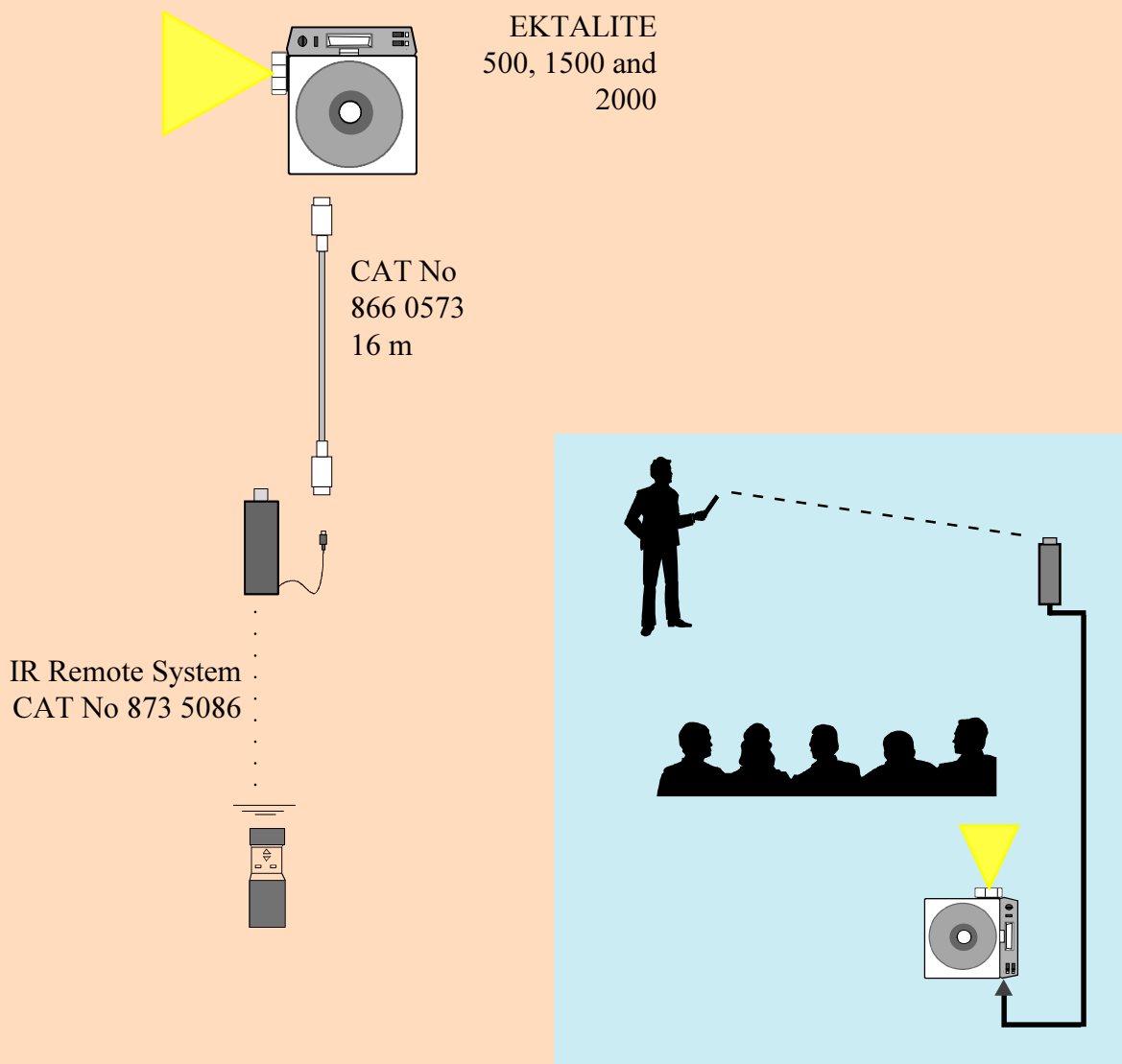

Parallel Projection IR and 2 Receivers

■ IR Remote System and a second receiver

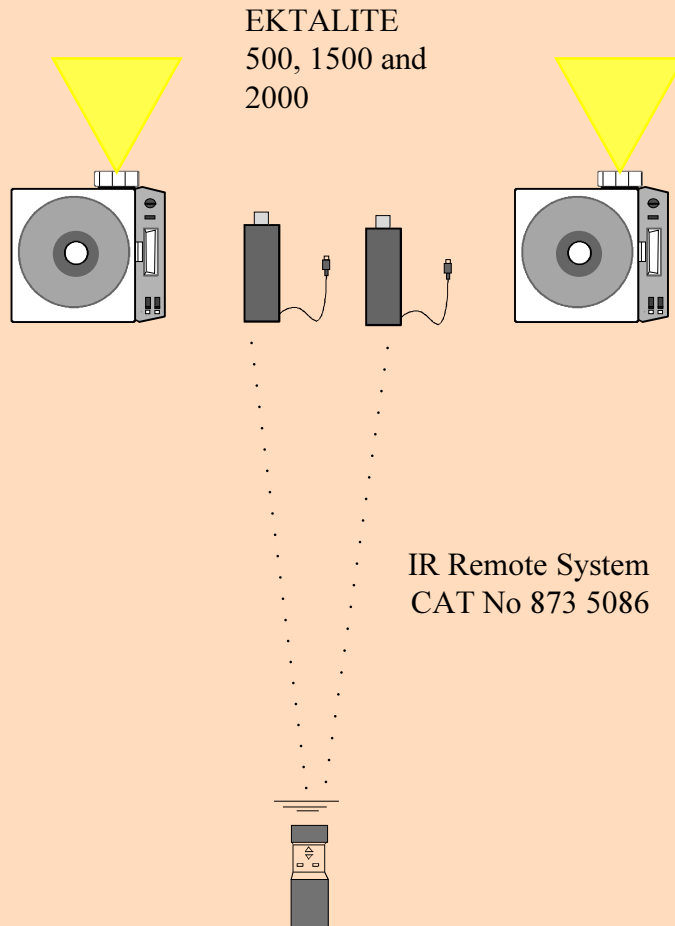

Note

Parallel projection (side by side projection, projection in harmony) is only possible with a second IR receiver. Unfortunately this item is not available as an accessory. So a second IR remote system is necessary.

Parallel Projection

Cable Remote + Twin Socket

■ Cable Remote and Twin Socket (OEM)

EKTALITE
500, 1500 and 2000

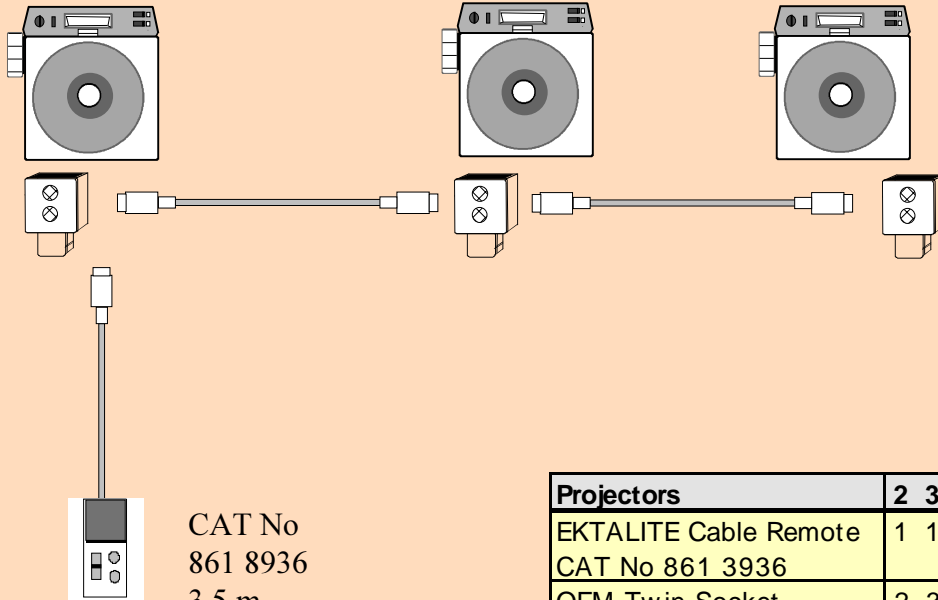

CAT No
861 8936
3.5 m

Projectors	2	3	4
EKTALITE Cable Remote	1	1	1
CAT No 861 3936			
OEM Twin Socket (Simultaneous Interface)	2	3	4
OEM Connecting Cable	1	2	3



Note

Twin Sockets (Simultaneous Interfaces) and Connecting Cables are **not** available from Kodak. Please see address list page 24 for OEM products.

Endless Projection Timer

■ Integrated Timer

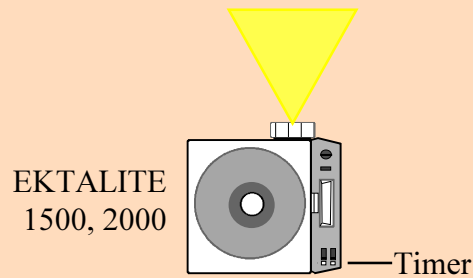

Setting : 3 - 22 sec

■ External Timer (no Kodak product)

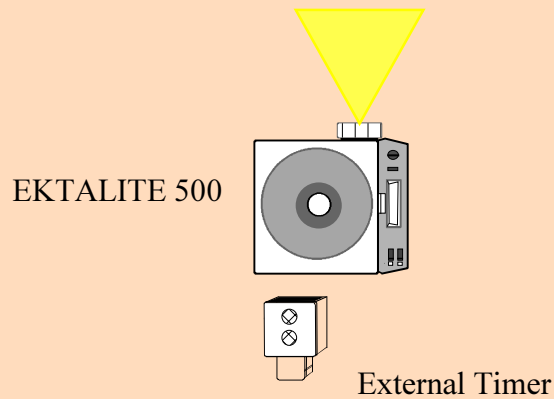

Note

An external timer is offered by some companies (see Addresses at page 24).

Autofocus

■ Important Note for use of Autofocus

EKTALITE
1500, 2000

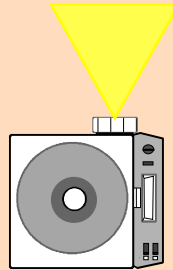

Important

Use **either** glass or glassless (cardboards) mounted slides! **Never mix up!**

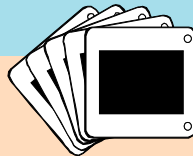

Slide Recording

- Creating 35 mm slides with film recorders

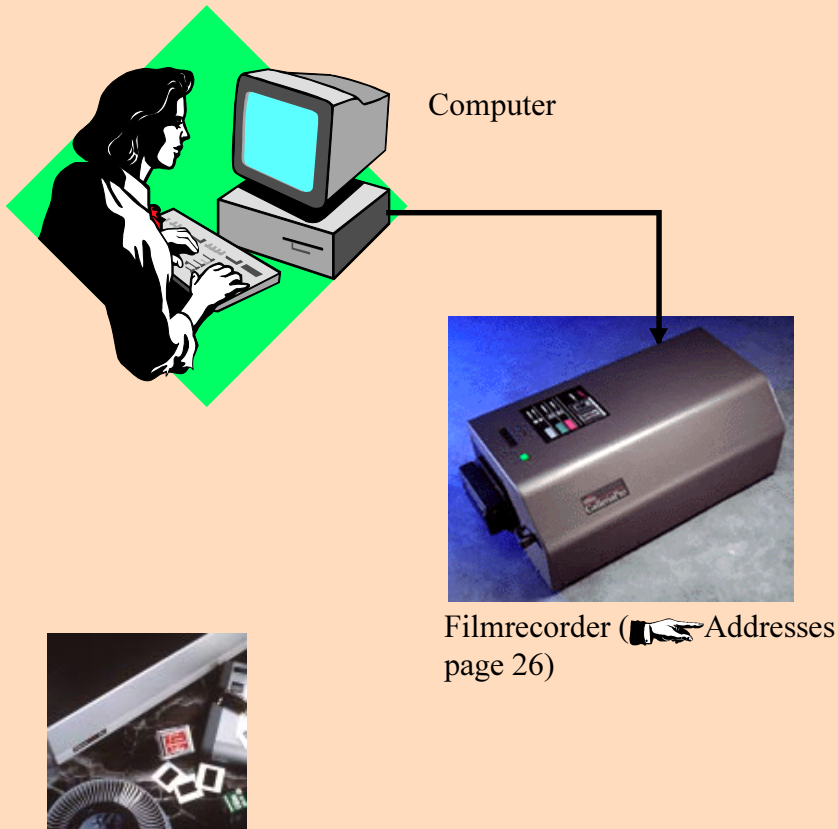

Lenses

General

			Ektalite
Kodak FF Lenses			
75-120 Zoom	CAT 847 0346		X
100-150 Zoom	CAT 143 3432		X
100-200 Zoom	CAT 712 5743		X
85 mm	CAT 712 5503		X
100mm	CAT 712 5511		X
180mm	CAT 712 5529		X
Kodak Ektapro Select FF Lenses			
75-120 Zoom	CAT 712 5479		X
87-200 Zoom	CAT 712 5487		X
200-300 Zoom	CAT 712 5495		X
36 mm	CAT 712 5446		no
93 mm	CAT 712 5453		X
150mm	CAT 712 5461		no



WEB User

You will find more details on lenses under [lenses](#).

Lens Calculator

You do not know what kind of lens you need for your projection venue? There is a formular but before getting nervous we can offer you a better solution: There are two well made lens calculators available on the WEB. It is freeware and can be easily downloaded.

Lenscalculator by Bässgen company:

Go to <http://www.dia.de> Click on [Bässgen](#) and go to [Download](#) and click on [SCREEN 2.0](#).

Lenscalculator by Stumpfl company:

Go to <http://www.stumpfl.com/E/Service/>

Lamps

General



	CAT No
EXR	82V 300W 35h 145 2259
FHS	82V 300W 70h 147 7678
EXY	82V 250W 200h 145 2143

Extra Bright Lamp Module

General

■ How it works

All current Kodak Slide Projectors are equipped with the Extra Bright Lamp Module offering 30% more light than compared to former models:

- √ **more light**
- √ **more brilliant colors**
- √ **higher contrast**
- √ **better legibility**

According to a new cold light mirror the biggest part of the IR (heat) light will be absorbed and not reflected. Therefore the heatfilter could be removed (see illustration). This system is unique to Kodak.

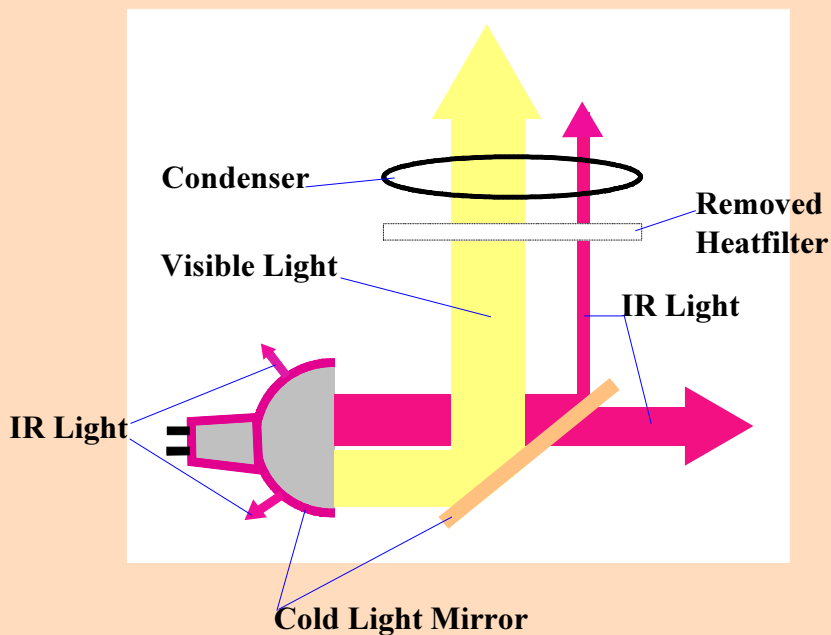

Extra Bright Lamp Module Lumen Output/ Compatibility

■ Lumen output for *standard and economy* setting

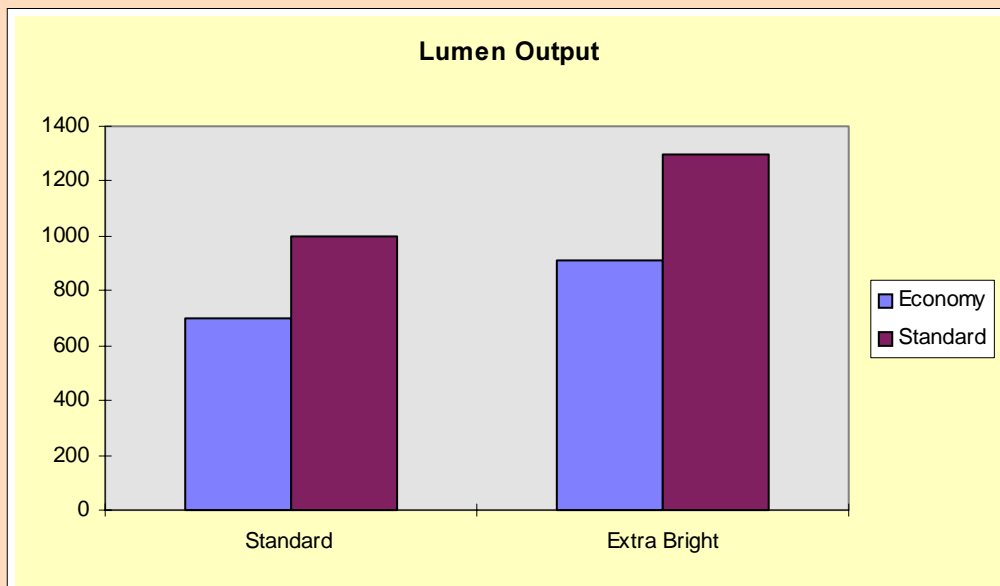

■ Upgrade

All former Ektalite Projectors can be upgraded with the Extra Bright Lamp Module:

Extra Bright Lamp Modules	CAT NO
Ektalite	816 7181

Extra Bright Lamp Module

Safety Precautions

According to a temperature increase in the slide gate which, therefore, needs more careful handling when using slides, mounts and lamps.

With the higher light output of the Extra Bright Lamp Module the temperature in the slide gate rises. To enable a smooth operation following hints should be considered:

- √ Use **only light** respectively **light gray** slide mounts (e.g. Wess slide mounts). Slide mounts with only one dark side or black side have to be sorted in respectively, mounted with the side facing the lamp. Please pay special attention when sorting your slide mounts in rear projections:

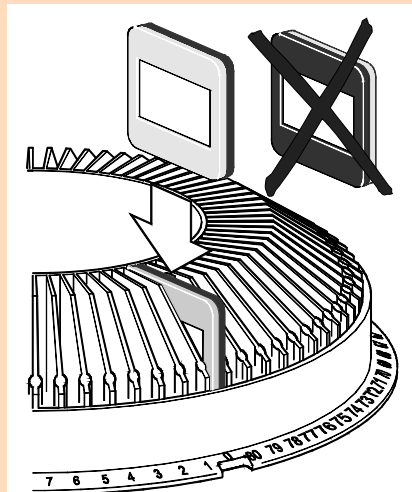

- √ Do not use a lamp type EXW/15 h for the projector (higher temperature - lamp not available from Kodak).
- √ Consider the room temperature! It may not exceed 35 degrees C!

If these hints are not considered, mounts may deform!

Carrying Case

- **Less Weight**
- **Flexible**
- **Soft Case**



CAT No 162 5136

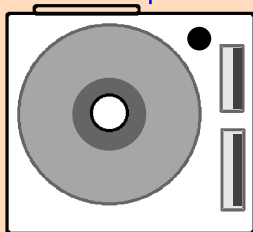

To take **projector, lens and tray**

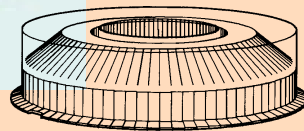

Stackloader

General

For a quick inspection of a stack of slides without the need to arrange them beforehand in a tray. A stack of thin glassless slides is loaded directly in the Stack Loader. Use the transport forward button to project the slides.

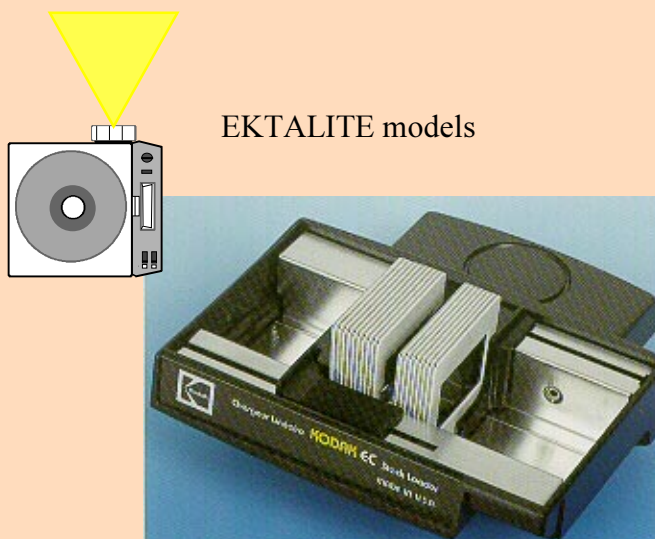

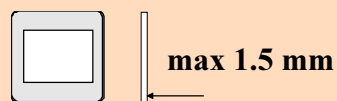

CAT No 151 4249

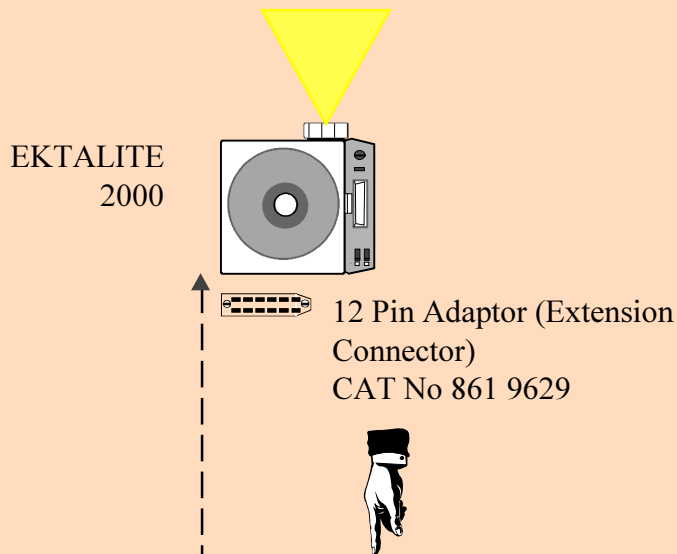

External Control Hardware Controllers

■ Hardware Controllers



Dissolve units (e.g. as
former Kodak PDC,
Stumpfl, Bässgen, ARION
etc) for 12 Pin Standard
(Addresses page  23)

Note

Only necessary for all dissolvers with
external TRIAC adaptor! It is not al-
lowed to plug such an adaptor unit di-
rectly on top of the projector's 12 pin
socket, as this could lead to a heat
build-up.

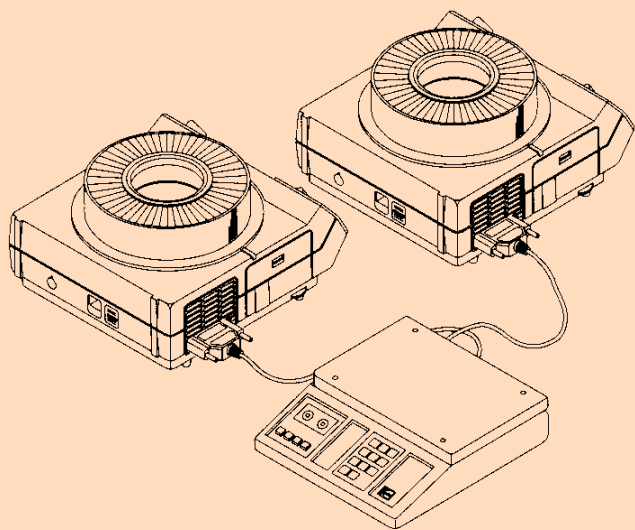

Specification Dimensions

■ Projector Measurements

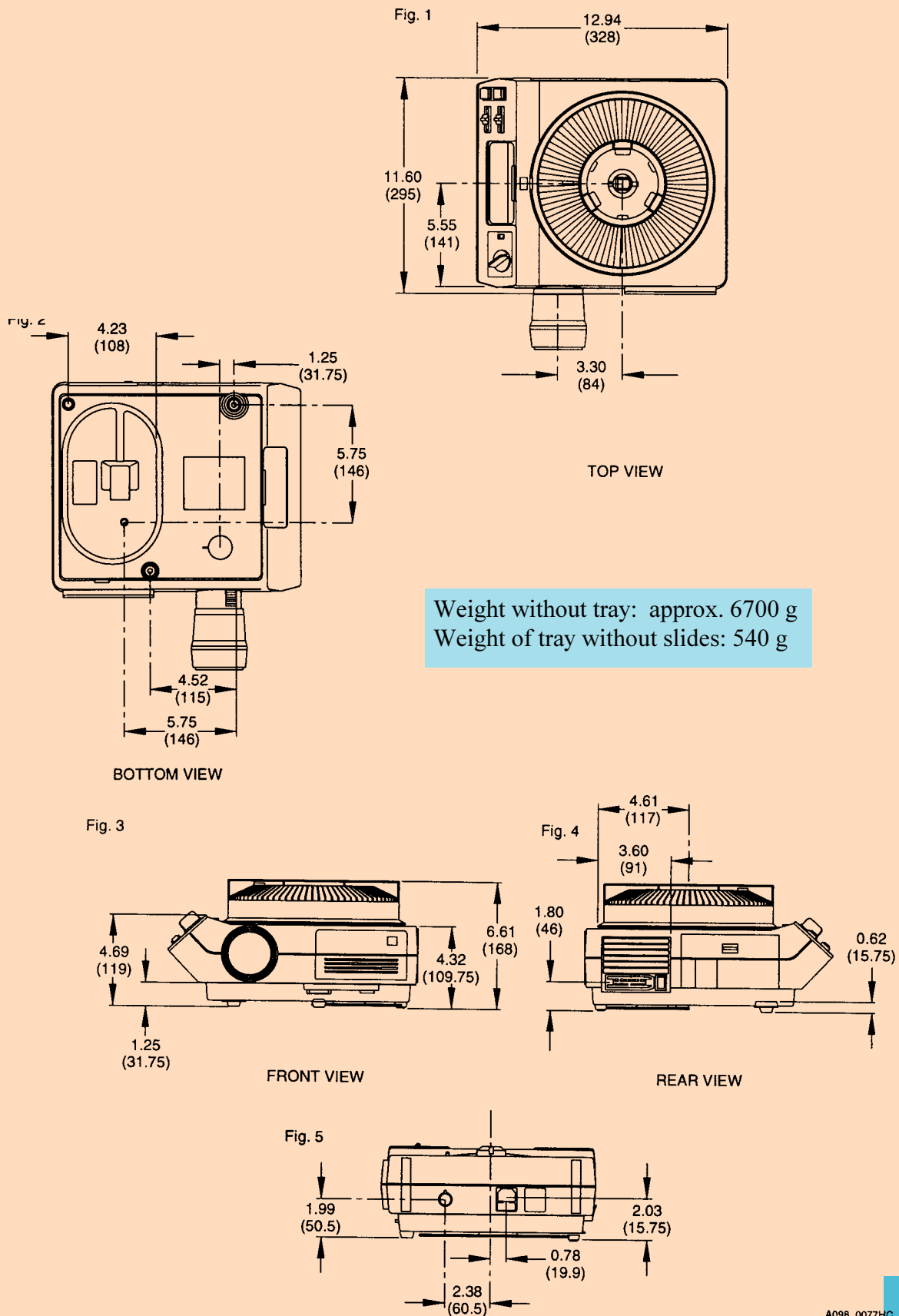

Specification Connectors

■ 6-pin Standard Projector Socket (remote socket)

- Pin 1 & 3 Slide Reverse
- Pin 2 & 3 Slide Forward
- Pin 3 Common (25.5 V ac)
- Pin 4 Focus motor (Lens in) when connecting Pins 5 & 6, and Pins 4 & 3
- Pin 5 Focus motor (Lens out) when connecting Pins 5 & 6, and Pins 4 & 3
- Pin 6 & 3 25.5 volts ac 500 mA

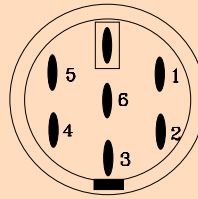

■ 12 Pin DIN Socket

- *a1 & b4 AC Power Supply 25.5 VAC 500 mA
- a2 Not used
- a3 & a4 For external lamp dissolve
- *a5 & b4 DC Power Supply, 20 VDC Pulsating 500 mA
- a6 & b1 Gate slide sensing shutter switch
- b3 & b4 Forward slide change
- b5 & b6 Zero position switch

*The combined total AC and DC current draw from the projector must not exceed 500 mA.

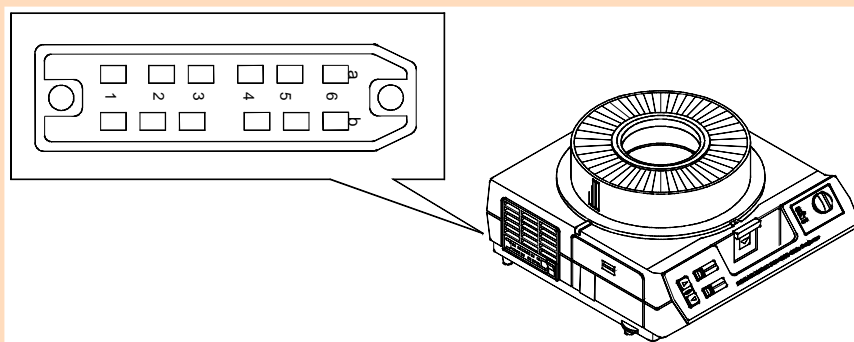



■ **Control via MIDI**

Use of slides on stage by musicians, artists

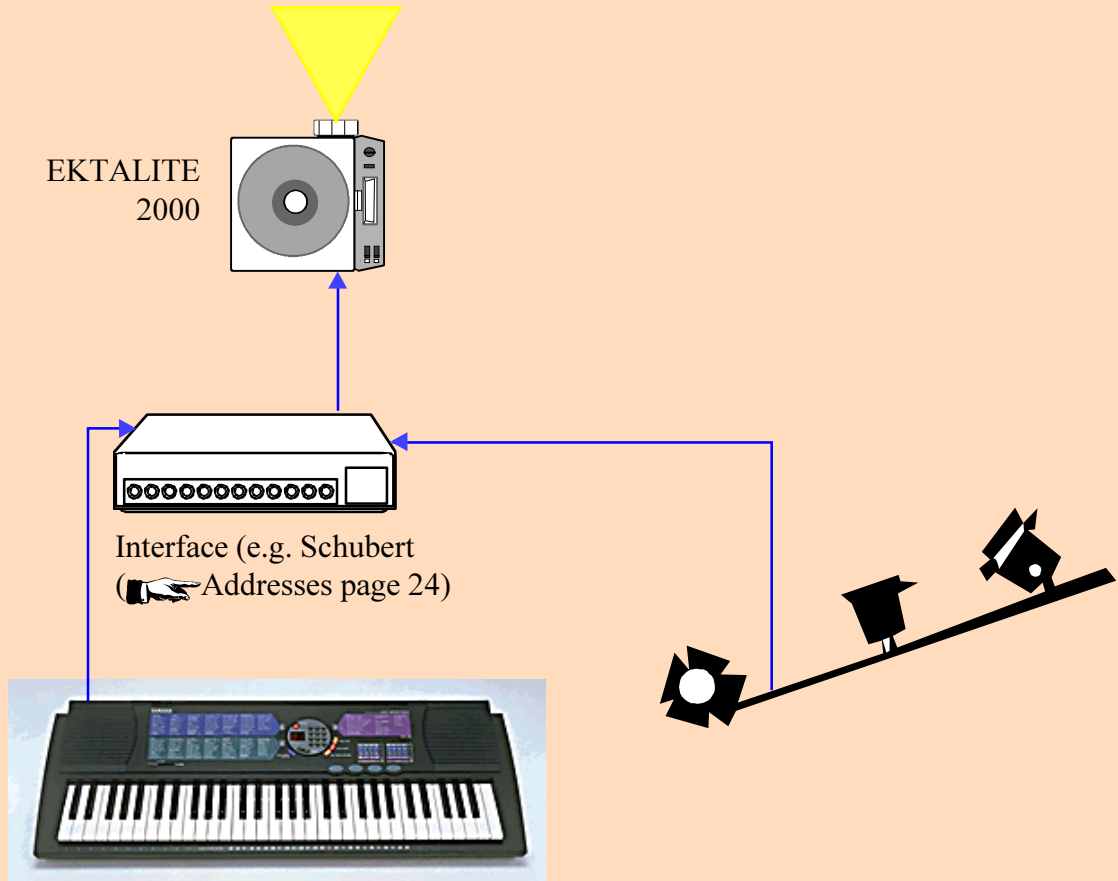

Keyboard with MIDI Interface

Analogy between music and slide sequences	
Music	Image
Note is sent	Slide transport will be executed
Sound level is increasing	Slide is fading up
Sound level stays constant	Freeze
Sudden sound level change	Flash
Sound level is decreasing	Slide is fading down

Addresses

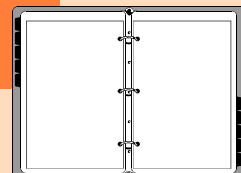

Company	Street	City	Country	Phone/FAX/WEB
Projector Control Systems - Hardware				
ARION	701 South 7th Str.	Delano, MN 55328	USA	(001) 612 972 3351 F: (001) 612 972 3524 www.arion-usa.com/
AVL	50 Barnes Park North	Wallingford, CT 06492	USA	(001) 203 269-8410 F: (001) 203 284-8414 www.usa.net/icia/avl
Bässgen	Hauptstraße 58	79104 Freiburg	Germany	(0049) 761 23953 F: (0049) 761 35042 www.dia.de/
Dataton	Box 257	S-581 02 Linköping	Sweden	(0046) 13114325 F: (0046) 13138445 www.dataton.se/
Electrosonic	Hawley Mill Hawley Rd	Dartford Kent DA2 7SY	England	(0044)-1322 282317 F: (0044)-1322 282215 www.electrosonic.co.uk
HEP	Road	3005 EC Rotterdam	The Netherlands	(0031) 10 418 3689
Müwo		72379 Hechingen-Stetten	Germany	(0049) 7471 15830
RMF	1275 Paramount PKW	Batavia, IL 60510	USA	(001) 708 879 0020 F: (001) 708 879 6749
Stumpfl	Rudigierstr. 8	A-4701 Bad Schallerbach	Austria	(0043) 7249 42811 F: (0043) 7249 42811 18 www.stumpfl.com/
Zygo Syst. Ltd.	48 Fallowfields	Bicester Oxon OX6 7Qs	England	(0044) 869 248261 F: (0044) 869 248 260
Software (Direct PC Control)				
ARION	701 South 7th Str.	Delano, MN 55328	USA	(001) 612 972 3351 F: (001) 612 972 3524 www.arion-usa.com/
COMM-TEC	Siemensstr. 22	73066 Uhingen	Germany	(0049) 7161 3000 0 F: (0049)7161 3000 11
M-Objects	Auf dem Berg 7	59387 Ascheberg	Germany	(0049) 2593 988 88 F:(0049) 2593 988 89 www.mobiects.com/
P. Ziegler	Van Gogh Platz 6	53844 Troisdorf	Germany	(0049) 2241 946 217 F:(0049) 2241 946 218 home.t- online.de/home/ziegler.av
Kodak Taiwan Ltd.	35, Chung Yang S, Rd., Sec. 2.	Pei Tou, Taipei	Taiwan	(0088) 6 2 2893 8178 F: (0088) 6 2 2893

Addresses

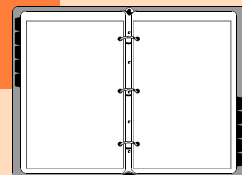

Company	Street	City	Country	Phone/FAX/WEB
Other Accessory (e.g. Slide Synchronizer)				
AVSZ	Tarweaker 63	2723 TB Zoetermeer	The Netherlands	(0031) 79 341 43 46 F: (0031) 793 425 687
Müwo	In den Maltwiesen 11	72379 Hechingen-Stetten	Germany	(0049) 7471 15830
Zeller	Wettsteinallee 15	4058 Basel	Switzerland	(0041) 6168 4343 F: (0041) 6168 3907
DMX 516 Theatre Controller				
AVAB	Salsmästaregatan 32	422 46 Hisings Backa	Sweden	(0046) 315 852 00 F. (0046) 31-582 999 www.avab.se
Midi Controller				
Schubert	Römerstr.29	52064 Aachen	Germany	(0049) 241 35 439 F:(0049) 241 406 961
1000 Hz Tape Decks				
ARION	701 South 7th Street	Delano, MN 55328	USA	(001) 612 972 3351 F:(001) 612 972 3534 www.arion-usa.com
3-Track Tape Decks				
Califone	Superior Street	Chatsworth CA 91311	USA	(001) 800 722 0500 www.califone.com
Yamaha	6600 Orangethorpe Avenue	Buena Park, CA 90620	USA	(001) 714 522 9011 www.yamaha.com
Fostex	15431 Blackburn Avenue	Norwalk, CA 90650	USA	(001) 562 921-1112 F. (001) 562 802-1964 www.fostex.com
Gebuhr	Imhoffstr. 4	90429 Nuernberg	Germany	(0049) 911 260 304 F:(0049) 911 268 738
Tascam	7733 Telegraph Rd.	Montebello, Ca 90640	USA	(001) 213 726-0303 F:(001) 213 727 7635 www.tascam.com
Single Projector dissolve				
Entré	2184 SE 53rd Avenue	Hillsboro OR 97123 7800	USA	(001) 503 649 4641

Addresses

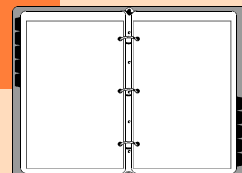

Company	Street	City	Country	Phone/FAX/WEB
Racks				
Baumann	Hauptstraße 58	79104 Freiburg	Germany	(0049) 761 23953 F: (0049) 761 35042
Chief	14310 Ewing Avenue	South Burnsville, MN 55337	USA	(001) 612 894-6280 F: (001) 612 894-
Roha	Bruno Jacoby Weg 11	70597 Stuttgart	Germany	(0049) 711 723621
Projection Lenses				
Buhl	1009 Beech Avenue	Pittsburgh, PA 15233	USA	(001) 412 321-0076 F: (001) 412 322
Docter	Industriegebiet	35641 Schoffengrund	Germany	(0049) 6445 609 0 F:(0049) 6445 609 165
Isco	Robert Bosch Breite 10	37013 Goettingen	Germany	(049) 551 5058 3 F: (0049) 551 5058 410
Navitar	200 Commerce Drv	Rochester, NY 14623	USA	(001) 716 359 4000 F:(001) 716 359 4999
Projection Screens				
Da-Lite	3100 N. Detroit Str	Warsaw, IN 46581 0137	USA	(001) 219 267 5101 F:(001) 219 267 5101 www.da-
Stumpfl	Rudigierstr. 8	A-4701 Bad Schallerbach	Austria	(0043) 7249 42811 F: (0043) 7249 42811 4

Addresses

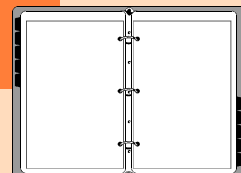

Company	Street	City	Country	Phone/FAX/WEB
Slide Recorders				
Agfa	Septestraat 27	B-2640 Mortsel	Belgium	(0032) -3-4442111 F: (0032) - 3-444 7094 www.agfa.com
Lasergraphics	20 Ada	Irvine, CA 92718	USA	(001) 714 753-8282 F: (001)(714) 727-9282 www.lasergraphics.com
Management Graphics,	1401 E. 79th Street	Minneapolis, MN 55425	USA	(001) 612 854-1220 F: (001) 612 851-6159 www.mgi.com
Mirus	3350 Scott Boulevard, Bldg. 48	Santa Clara, CA 95054	USA	(001) 408 980-660 F. (001) 408 980-6601 www.mirus.com
Polaroid	549 Technology Square	Cambridge, MA 02139	USA	(001)(781) 386-2000 www.polaroid.com
Other Places of Interest				
Gavi	333 West Merrik RD	Valley Stream, NY 11580	USA	F:(001) 516 568 2057
Jobo	Koelnerstr. 58	51645 Gummersbach	Germany	(0049) 2261 54525 F:(0049) 2261 54542 www.jobo.com
Leica	Saarbrueckenerstr. 263	38116 Braunschweig	Germany	(0049) 531 5900 479 F:(0049) 531 5900 489 www.leica-camera.com
Pacon	106 Baker Techn. Plaza 6121 Baker Road	Minnetonka, MN 55345	USA	(001) 612 936 9500 F:(001) 612 936 9509 www.pakon.com
Telex	9600 Aldrich Ave Sough	Minneapolis, MN 55420	USA	F: (001) 612 887 5588 www.telex.com
Slide Mounts				
Alfi	P.O.B 10 20 47	86010 Augsburg	Germany	(0049)-821-80867-0 F: (0049)-821-80867-40
Geimuplast	P.O.B 1364	82453 Garmisch-Partenkirchen	Germany	(0049) 8821 6850 F: (0049) 8821 685100
GEPE	Baarerstr. 43	6304 Zug	Switzerland	(0041) 41 711 7588 F: (oo41) 41 711 2870
Wess	70 Commerce Drive	Hauppauge, NY 11788	USA	F:(001) 516 231 0608 www.wesspl.com

Editorial

The Quick Reference was created and published by Kodak AG, Germany. In case of any questions, requests, useful ideas, please get in direct contact with Kodak. The address is:

Kodak AG
PT CMS
Hedelfingerstr. 60
70327 Stuttgart
Germany
Phone: int +711 406 5151
Fax: int + 711 406 5367
E-mail: heinrich@kodak.com

Stuttgart, July 1998